

P-963ESP

**AM/FM/MPX RADIO WITH
FOLD-DOWN DETACHABLE FRONT PANEL,
COMPACT DISC PLAYER, MP3 CD PLAYBACK,
CD CHANGER CONTROLS,
REMOTE CONTROL
AND QUARTZ CLOCK**

**COMPACT
disc
DIGITAL AUDIO**



OWNER'S MANUAL

**128-6981
1 of 20**

INDEX

	Page
<i>Operating Instructions</i>	3 - 8
<i>Setting the Clock</i>	8
<i>CD Player Error Codes</i>	9
<i>Care and Maintenance</i>	9
<i>Notes on Discs</i>	10
<i>Electronic Skip Protection</i>	10
<i>Specifications</i>	11
<i>CD Changer Controls</i>	12
<i>CD Changer Error Codes</i>	13
<i>Wireless Remote Control Operation</i>	14
<i>Playing MP3 Music Files</i>	15
<i>Troubleshooting</i>	18
<i>Warranty</i>	19

OPERATING INSTRUCTIONS

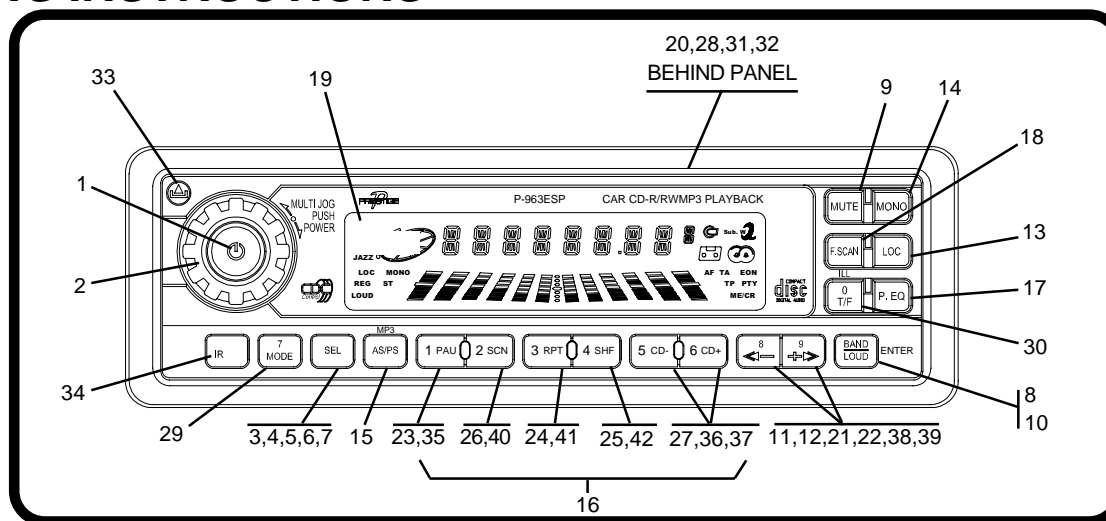

① ON - OFF POWER BUTTON (⏻)

Press the power button in the center of the MULTI JOG volume control knob to turn the unit on and off when the ignition switch is on. If the radio is off when the ignition switch is turned off, the POWER button must be pressed to turn on the radio after the ignition switch is turned on. If the ignition switch is turned off while the radio is on, the radio will come on automatically when the ignition switch is again turned on, or when a disc is inserted for play. When the radio is on, momentarily pressing this button will change the LCD backlight intensity between low, medium and high. Press the button for at least 3 seconds to turn the unit off.

② VOLUME (MULTI JOG) CONTROL

To increase the volume level, rotate the MULTI JOG Volume control knob clockwise (CW). The volume will increase and the level will

be shown on the display panel from a minimum of **00** to a maximum of **100**. To decrease the volume level, rotate the Volume control counter-clockwise (CCW). The volume will decrease as shown on the display panel. This control also includes the Power On/Off button ① for turning the unit on and off.

③ SELECT BUTTON (SEL)

This button is used to select the audio function (bass ④, treble ⑤, balance ⑥, or fade ⑦) to be adjusted using the Volume control ②. Pressing the Select button once will set the unit for volume adjustment (**VOL** will appear on the display panel). Pressing the button additional times will select bass adjustment (**BAS** on display), treble (**TRB**), balance (**BAL**), or fader (**FAD**). The display will automatically return to the normal indication 5 seconds after the last adjustment or when another function is activated.

④ BASS CONTROL

To adjust the bass level, first select the Bass mode by pressing the SEL button ③ so the **BAS** indication appears on the display panel. Within 5 seconds of choosing the Bass mode, rotate the Volume control ② CCW or CW to adjust the bass response as desired. The level will be shown on the display panel from a minimum **--10** to a maximum of **10 (00** indicates flat response). The display will automatically return to the normal indication 5 seconds after the last adjustment or when another function is activated.

NOTE: If the BAS or TRB functions are set while the Equalizer function (P.EQ) is active, the Equalizer function will automatically revert to the **FLAT** setting.

⑤ TREBLE CONTROL

To adjust the treble level, first select the Treble mode by pressing the SEL button ③ so the **TRB** indication appears on the display panel. Within 5 seconds of choosing the Treble mode, rotate the Volume control ② CCW or CW to adjust the treble response as desired. The level will be shown on the display panel from a minimum of **--10** to a maximum of **10 (00** indicates flat response). The display will automatically return to the normal indication 5 seconds after the last adjustment or when another function is activated.

⑥ LEFT/RIGHT BALANCE CONTROL

To adjust the left-right speaker balance, first select the Balance mode by pressing the SEL button ③ so the **BAL** indication appears on the display panel. Within 5 seconds of choosing the Balance mode, rotate the Volume control ② CCW to adjust the stereo balance to the left channel speakers, or CW to adjust it to the right channel speakers. The balance position will be shown on the display panel from **BAL 10L** (full left) to **BAL 10R** (full right). When the volume level between the left and right speakers is equal, **BAL L=R** will be shown on the display panel. The display will automatically return to the normal indication 5 seconds after the last adjustment or when another function is activated.

⑦ FRONT/REAR FADER CONTROL

To adjust the front-rear speaker balance, first select the Fader mode by pressing the SEL button ③ so the **FAD** indication appears on the display panel. Within 5 seconds of choosing the Fader mode, rotate the Volume control ② CW or CCW to adjust the front-rear speaker balance as desired. The fader position will be shown on the display panel from **FAD 10R** (full rear) to **FAD 10F** (full front). When the level between the front and rear speakers is equal, **FAD F=R** will be shown on the display panel. The display will automatically return to the normal indication 5 seconds after the last adjustment or when another function is activated.

⑧ LOUDNESS CONTOUR (LOUD)

When listening to music at low volume levels, this feature will boost the bass and treble ranges to compensate for the characteristics of human hearing. Press and hold the BAND/LOUD button to activate this feature and the indication **LOUD ON** will appear on the display panel for 5 seconds. Press and hold the button again to deactivate the feature, and **LOUD OFF** will appear on the display panel for 5 seconds.



⑨ AUDIO MUTE SELECTOR (MUTE)

Press this button momentarily to mute the volume from the system (**MUTE** will appear flashing on the display panel). Pressing this button again, adjusting the Volume control ②, or pressing any other button, will return to the volume level setting in use before the Mute function was activated.

⑩ AM/FM BAND SELECTOR (BAND)

Each time the BAND/LOUD button is pressed, the radio band is changed. The indications **F1, F2, F3** or **AM** will appear in the display panel according to your selection.

⑪ AUTOMATIC UP/DOWN TUNING (/)

To select a radio station in the automatic mode, momentarily press the Up Tuning () button to advance the unit to the next available station, or the Down Tuning () button to tune downward to the next available station. The radio will automatically seek the next strongest station. If the Local mode (LOCAL) is active, the radio will seek the next strongest local station when either button is pressed.

⑫ MANUAL SEEK TUNING

This function is used to search rapidly upward or downward for a desired station. By pressing either tune button for more than 2 seconds, the radio will enter the **MANUAL** seek mode as displayed momentarily on the panel. When either button is pressed and held in this mode, the radio will tune rapidly up or down and will stop at the station of choice when the button is released. A momentary press of either button in this mode will cause the radio to tune upward or downward one step at a time. If tuning is not activated within 5 seconds of entering the **MANUAL** mode, the radio will automatically revert to the default **AUTO** mode as indicated momentarily on the panel.

⑬ LOCAL/DISTANT SELECTOR (LOC)

This feature is used to select the strength of the signals at which the radio will stop during Automatic Up/Down Tuning. Pressing the button will select the Local setting (**LOCAL** will appear on the display panel for 5 seconds, and **LOC** remains on the display) and tuning will select only strong (local) stations for reception. Pressing the button again will select the Distant setting (**DX** will appear on the display panel for 5 seconds) and the tuning will stop at a wider range of signals, including weaker (more distant) stations. **LOC** disappears from the display.

⑭ FM MONO SELECTOR (MONO)

During FM radio operation, this button is used to select mono or stereo reception of the broadcast signal. Under normal reception conditions, the unit should be left in the stereo mode as indicated by **ST** on the display panel when tuned to an FM stereo signal. If the stereo signal is too noisy for comfortable listening, press the MONO button to switch to

mono reception (the **ST** indication will disappear from the display panel, **MONO** will appear for 5 seconds, and **MONO** will remain at the bottom left of the display). To return to stereo reception mode, press the button again; **STEREO** will momentarily appear on the display panel for 5 seconds and the **ST** indication returns.



⑮ PRE-SET SCAN (PS) AUTO-STORE TUNING (AS)

Press this button momentarily to scan the stations pre-set into the memories on the 3 FM bands or the AM band. The unit will stop at each pre-set station for 5 seconds before continuing to the next pre-set station (the pre-set number on the display panel will flash during Pre-Set Scan operation). Press the button again momentarily to stop Pre-Set Scan operation and remain on the selected frequency.

Pressing and holding the button for longer than 2 seconds will activate the Auto-Store Tuning feature which will automatically scan and enter up to 6 stations into the 6 pre-set memories on each FM band or the AM band, if selected. After entering the stations into memory, the unit will automatically stop at each station for 5 seconds so each can be heard. Press the AS/PS button again to remain on the desired station. If you have already set the pre-set memories to your favorite stations, activating the Auto-Store Tuning feature will erase those stations and enter the new ones. This feature is most useful when traveling in a new area where you are not familiar with the local stations.

⑯ STATION PRE-SET MEMORIES

To set any of the 6 pre-set memories in each band, use the following procedure:

1. Turn the radio on and select the desired band.
2. Select the first station to be pre-set using the Automatic Up/Down , or Manual Seek  Tuning Controls.
3. Press and hold the pre-set button to be set for approximately 2 seconds. The pre-set number will appear on the display panel indicating that the station is now set into that pre-set memory position. The station can now be recalled at any time by pressing that button.
4. Repeat the above procedure for the remaining 5 pre-sets on that band and for the other 3 bands on the unit.



⑰ EQUALIZER (P. EQ) BUTTON

The P. EQ button applies preset sound effects to the unit's audio output signal. The P. EQ button, when pressed, will activate one of the following operating modes (**CLASSICS**, **POP M**, **ROCK M**, **DSP OFF** or **FLAT**). If the Sound Equalizer function is active, as displayed on the panel, and the bass and/or treble level is set, the preset Equalizer function reverts to the **FLAT** setting. On the other hand, if the Sound Equalizer function is activated, the bass/treble setting(s) are ignored. Conversely, when the preset Equalizer function is not active (Digital Signal Processor (**DSP OFF**)), the unit returns to the user set bass and treble levels.

⑱ STATION SCAN (F.SCAN) BUTTON



When this button is pressed during radio operation, each station in the current band will be scanned in the upward direction; each displayed station will flash for 5 seconds before moving on to the next station. If the local mode is active, only the stronger, nearby stations in the current band will be scanned. When the desired station appears, press the F.SCAN button again to remain on that frequency.

⑲ LIQUID CRYSTAL DISPLAY PANEL

The Liquid Crystal Display (LCD) panel displays the frequency, time and activated functions, including a rotating disc icon () with a disc in indicator ().



NOTE: It is a characteristic of LCD panels that, if subjected to cold temperatures for an extended period of time, they may take longer to illuminate than under normal conditions. In addition, the visibility of the numbers on the LCD may slightly decrease. The LCD read-out will return to normal when the temperature increases to a normal range.

⑳ DISC SLOT



With the label surface facing up, gently insert the disc into the slot until the soft-loading mechanism engages and disc play begins. **S--CDP** will appear momentarily; the  indication will become animated, and  appears together with the track number and elapsed time

CAUTION: This unit is designed for play of standard 5" (12cm) Compact Discs **ONLY**. Do not attempt to use 3" (8cm) CD-Singles in this unit, either with or without an adaptor, as damage to the player and/or disc can occur. Such damage will not be covered by the Warranty on this product.

㉑ TRACK SELECT

These buttons are used to quickly select the beginning of a particular track. With each momentary press of the Forward Track Select button (), the next higher track number will be selected as shown on the display panel. Similarly, with each momentary press of the Backward Track Select button (), the next lower track number will be selected.

㉒ CUE/REVIEW FUNCTIONS

High-speed audible search to any section of the disc can be made by the Cue and Review functions. Press and hold the Cue button () to advance rapidly in the forward direction or the Review button () to advance rapidly in the backward direction. During either function, the elapsed time within each track will automatically be shown on the display panel.

㉓ DISC PAUSE (PAU) SELECT

The Pause function is used to freeze disc play when the CD player is in use. **S--PAUSE** will appear on the display. Press this button again to resume disc play; the **S--PAUSE** indication will disappear.

㉔ REPEAT PLAY SELECTOR (RPT)

During disc play, press this button to repeat the play of the selected track (**S--RPT** will appear on the display panel). Play of the track will continue to repeat until the button is pressed again and the **S--RPT** indication disappears from the display panel. Repeat Play mode will also be cancelled by activating the Shuffle Play ㉕ or Track Scan ㉖ functions.

㉕ SHUFFLE PLAY SELECTOR (SHF)

During disc play, press this button to play the tracks on the disc in a random shuffled order (**S--SHF**) will appear on the display panel). In

Shuffle Play mode, pressing the Forward Track Select (⏮➡) or Backward Track Select (⏭⏮) will also select tracks in a random order instead of the normal progression. Additional presses will select tracks in random order. The Shuffle Play mode can be cancelled by pressing the button again (**S--SHF** indication will disappear from the display panel) or by activating the Repeat Play ⑳ or Track Scan ㉔ functions.

㉔ TRACK SCAN (SCN)

During disc play, press this button to play the first 10 seconds of each track on the disc (**S--SCN** will appear on the display panel with the track number). When a desired track is reached, press the Scan button again to cancel the function and play of the selected track will continue. Track Scan mode will also be cancelled by activating the Repeat Play ㉔ or Shuffle Play ㉕ functions.

㉕ DISC SELECT UP/DOWN (CD-/CD+)

These buttons are used to select the desired disc for play during changer operation. To advance to a higher number disc, press the CD+ button, and to return to a lower number disc, press the CD- button. The number of the disc in play will be shown on the display panel.

㉖ DISC EJECT (▲)

When this button is pressed, disc play is stopped, the disc is ejected and the unit will change to radio operation. If the disc is not removed from the unit within 15 seconds, the disc will be reloaded (⏮➡ will reappear).

㉗ MODE SELECTOR (MODE)

During radio play, press the MODE button to select operation of the CD Player or the optional CD changer. Refer to the CD Changer Controls section for specific operating instructions.

If the button is pressed when no CD changer is connected to the unit, no changer indications will appear on the display panel. The unit will then return to radio operation. If a changer is connected, but no magazine is installed, **NO MAGAZ** will appear on the display. To return to CD

Player operation (if a disc is loaded in the unit), press the button again. During disc play, press this button to change to radio operation without ejecting the disc.

㉘ ILLUMINATION TIME/FREQUENCY SELECTOR (ILL T/F)

Pressing the Illumination Time/Frequency (ILL T/F) button momentarily will display the time of day for 5 seconds, after which the display will automatically return to the radio, CD Player or CD changer display, depending on which mode was currently active. To set the correct time of day, refer to the procedure for Setting the Clock. Pressing and holding this button (ILL T/F) for 2 seconds will change the panel backlighting (Illumination) between Green and Red.

㉙ THEFT-DETERRENT LED

Located on the chassis behind the front panel, a light-emitting diode (LED) will flash when the panel is removed. The flashing light serves as a visual warning to the would-be thief that the unit has been disabled by removal of the front panel.

㉚ RESET BUTTON

A RESET button is located on the front of the chassis (front panel must be lowered to access the button). The reset circuitry is provided to protect the microprocessor circuitry and should only be activated under the following circumstances as it will erase the time and pre-set memories.

1. Upon initial installation after all wiring is completed.
2. If there is a malfunction of any of the switches on the unit, pressing the RESET button may clear the system and return to normal operation.

㉛ FRONT PANEL RELEASE BUTTON

This button is used to release the mechanism that holds the front panel to the chassis. To detach the front panel, press the button so that the panel drops to the lowered position. Press the RELEASE bar at the front edge of the panel and slide the panel off of the front mounting plate. After removing the panel, push the front mounting plate back up to the vertical position.

③④ INFRARED (IR) WINDOW

This window covers the remote IR sensor which responds to the IR signal from the remote control for selection of radio functions.

NOTES ON USE OF FRONT PANEL

1. Make sure the front panel is oriented correctly when sliding it into the front mounting plate, as it cannot be attached when up-side down. Use moderate pressure to fully seat the panel into position.
2. To verify correct panel installation, swing the panel assembly up into position until it locks easily into place. If any resistance is encountered, re-check panel orientation in chassis mounting plate.

NOTE: When the faceplate is in the upright position, press the release button to lower the faceplate away from the radio chassis.

3. When taking the front panel with you, please use the supplied carrying case to protect the panel from dirt and damage. Make sure there is no dust or dirt on the electrical terminals on the back of the panel as this could cause intermittent operation or other malfunctions.

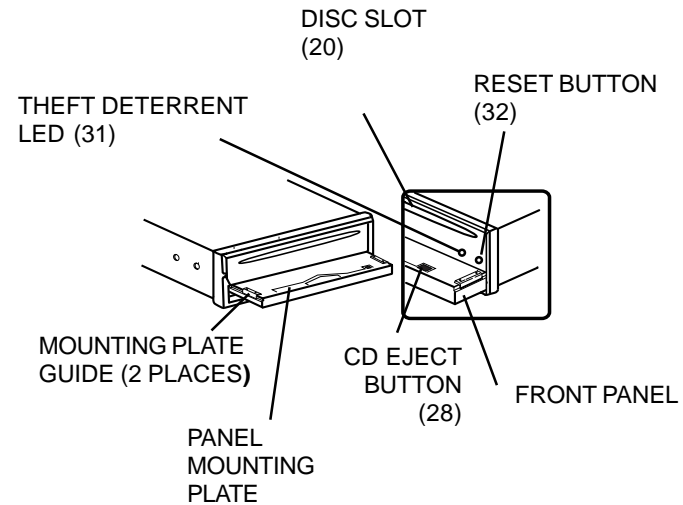

SETTING THE CLOCK

1. Switch the vehicle ignition and radio on.
2. Momentarily press the Time/Frequency (T/F) Select button ③① so that the time is shown on the display panel.
3. Press and hold the Time/Frequency button until the time display begins flashing. While the display is still flashing, press the Up Tuning (⊕⏪) button to adjust the hours and then the Down Tuning (⏩⊖) button to adjust the minutes to the correct time.
4. Five seconds after the last hour or minute adjustment is made, the time will be set in the unit and the display will return to the normal indication.

CD PLAYER ERROR CODES

If a problem should develop while operating the CD player, an error code (**ER-1**, **ER-2**, **ER-3**, etc.) may appear on the display panel. This can indicate a number of problems with the unit, including a mechanical error or an error in the microprocessor control of the player. If an error code should appear, try ejecting and re-loading the disc into the player. While the disc is out of the unit, make sure it is clean, undamaged, and loaded correctly (label surface up). You may also try activating the RESET button  on the unit, but this will also erase the time and pre-set memories.

If the suggested measures do not solve the problem, contact an approved warranty station near you for further assistance.

CARE AND MAINTENANCE

The radio section of your new sound system does not require any maintenance. We recommend you keep this manual for reference on the many features found in this unit as well as how to set the clock. The compact disc player section also requires no routine maintenance, but proper understanding of its use and handling will help you obtain maximum enjoyment of its capabilities. The following points should be observed:

- When cleaning the interior of the vehicle, do not get water or cleaning fluids on the unit.
- The CD player is a precision instrument and will not operate properly in extreme hot or cold. In case of such conditions, wait until the interior temperature of the vehicle reaches a normal temperature before using the player.
- If the temperature inside the player gets too hot, a protective circuit will automatically stop play of the disc. In this case, allow the unit to cool off before operating the player again.
- Never insert anything other than a 5" (12 cm) compact disc into the player as the mechanism can be damaged by foreign objects.
- Do not attempt to use 3" (8 cm) CD-Single discs in this unit, either with or without an adaptor, as damage to the player and/or disc may occur. Such damage will not be covered by the Warranty on this product.
- When not using the disc player, always remove the compact disc.
- When the vehicle warms up during cold weather or under damp conditions, moisture may condense on the lens of the disc player. Should this occur, the player will not operate properly until the moisture has evaporated.
- The unit is designed with a vibration dampening CD mechanism to minimize interruption of disc play due to normal vibration in a moving vehicle. When driving on very rough roads, however, occasional sound skips may occur. This will not scratch or damage the disc and normal play will resume when the rough conditions cease.

HANDLING COMPACT DISCS

Dirt, dust, scratches, and warpage can cause skips in the playback and deterioration of sound quality. Please follow these guidelines to take care of your compact discs:



- Use only compact discs with the mark:
- Fingerprints, dust, and dirt should be carefully wiped off the disc's playing surface (shiny side) with a soft cloth. Wipe in a straight motion from the inside to the outside of the disc.
- Never use chemicals such as record sprays, household cleaners or thinner to clean compact discs. Such chemicals can irreparably damage the disc's surface.
- Discs should be kept in their storage cases when not in use.
- Do not expose discs to direct sunlight, high temperatures or high humidity for extended periods.
- Do not stick paper, tape, or labels on the disc surfaces nor write on them with any type of marker.

NOTES ON DISCS:

Attempting to use non-standard shape discs (e.g.; square, star, heart) may damage the unit. Be sure to use round-shape CDs only in this unit.

NOTES ON CD-Rs (Recordable CDs)/CD-RWs (Rewritable CDs):

1. Be sure to use discs with the following marks only for play in



2. The unit cannot play a CD-R or CD-RW that is not finalized.
(Please refer to the manual of your CD-R/CD-RW software for more information on the finalization process.)
3. Depending on the recording status, conditions of the disc and the equipment used for the recording, some CD-Rs/CD-RWs may not be played on this unit.

RELIABLE PLAYBACK:

To ensure more reliable playback, please note the following recommendations:

1. Use CD-RWs with speed 1x to 4x.
2. Use CD-Rs with speed 1x to 8x, and write with speed 1x to 2x.
3. Do not play a CD-RW which has been written on more than 5 times.

NOTES ON MULTI-SESSION DISCS:

1. If the first track of the first session is audio CD data, then the unit will play only the audio CD data.
2. When the first track of the first session is not audio CD data, but an MP3 file is included on the disc, then only the MP3 files will be played back and other data (including CD data) is skipped.

ELECTRONIC SKIP PROTECTION (ESP)

The CD Player in this unit is equipped with Electronic Skip Protection (ESP) circuits. This capability enables the CD Player to project disc play approximately 10 seconds ahead of its current play position. As a result, if a severe road bump is encountered during Player operation, play of the current track will not be interrupted, or result in a skip.

SPECIFICATIONS

Size:	7" W x 2" H x 6.49" D 178 mm x 50 mm x 165 mm
Operating Voltage:	12 volts DC, negative ground
Output Power:	160 watts maximum (40 watts x 4 channels)
Output Wiring:	Floating-ground type designed for 4 speaker use. The amplifiers in this unit are NOT designed for use with 2 speakers. Two-Channel RCA Line Outputs.
Output Impedance:	Compatible with 4 - 8 ohm speakers
Pre-Amp Output:	1.0 V
Tuning Range:	AM: 530 - 1,710 KHz (10 kHz step) FM: 87.5 -107.9 MHz (200 kHz step)
Sensitivity:	AM: 20 uV FM: 12 dBf
FM Stereo Separation:	>30 dB at 1kHz
CD Frequency Response:	20 – 20 kHz. +/-3 dB
CD Signal/Noise Ratio:	>60 dB
CD Channel Separation:	>55 dB
CD Distortion:	0.2%
ESP Duration:	10 seconds

*Specifications are subject to change without notice.

CD CHANGER CONTROLS

Built into this radio are controls to operate an optional CD changer. Please check with your Prestige/Audiovox car stereo specialist or call 1-800-645-4994 for recommendations of the models that will work with this radio. Connection between the radio and CD changer is made using the supplied ISO-to-DIN 8-pin adapter cable, Part Number P956CDC.

Once the changer is installed and properly connected, it may be necessary to press the RESET button behind the radio front panel to initialize the complete installation.

Adjustment of the audio functions (volume, tone, balance, and fader) for the CD changer operate in the same manner as they do for radio play. The following controls will operate the CD changer when it is installed and connected to this radio. Refer to 128-6982 for specific wiring instructions for an optional CD changer; also refer to the owner's manual included with the CD changer for instructions on the installation and correct loading and use of the CD magazine.

③⑤ CD CHANGER PAUSE/PLAY SELECTOR (PAU)



During radio, or CD player operation, press the MODE button to select operation of the CD changer. **CDC** will appear, disc play will begin, the disc and track number will be shown on the display panel, and the disc icon () will become animated. If a new magazine has been loaded into the changer, play will begin from the first track of the first disc in the magazine. If a magazine was already in the changer, play will resume from the track on the disc previously in play.

During CD changer play, pressing the PAU button once will stop changer play; **PAUSE** will appear on the display and the disc icon will remain stationary. To resume disc play, press the PAU button again and disc play will resume from the point at which it was interrupted.



③⑥ & ③⑦ DISC SELECT (CD+/CD-)

These buttons are used to select the desired disc for play. To advance to a higher number disc, press the CD+ button (③⑥). To return to a lower number disc, press the CD- button (③⑦). The number of the disc in play will be shown on the display panel.

③⑧ TRACK SELECT (/)

This button is used to quickly select the beginning of a particular track. With each momentary press of the Forward Track Select button (), the next higher track number will be selected as shown on the display panel. Similarly, with each momentary press of the Backward Track Select button (), the next lower track number will be selected.

③⑨ FOWARD/REVERSE SEARCH (CUE/REVIEW)

High-speed audible search to any forward or reverse section of the disc can be made with this feature. Press and hold the forward (cue) button () to advance rapidly in the forward direction, or press and hold the reverse (review) button () to advance rapidly in the reverse (backward) direction. In either case, the disc icon will rotate faster when search is active.

④① TRACK SCAN SELECTOR (SCN)

When the SCN button is momentarily pressed, the **SCN** indication will replace the **CDC** indication on the display panel, and the first 10 seconds of each track on the disc will be played in order. When a desired track is reached, press the SCN button again and play of the selected track will continue (**SCN** will disappear from the display panel and **CDC** will reappear). The Track Scan mode will also be canceled by activating any other disc function (Track Select, Repeat or Random).

When the SCN button is pressed and held for more than 2 seconds, the disc scan mode is activated; **DSN** will appear on the display and the first 10 seconds of the first track on each disc will be played in disc order. This mode is canceled in the same manner as before.

④① TRACK REPEAT PLAY SELECTOR (RPT)

When the RPT button is momentarily pressed, the **RPT** indication will replace the **CDC** indication on the display panel and play of the current track will be continually repeated until the Track Repeat mode is canceled by pressing the RPT button again or by activating the Track Select, Random Play or Scan functions.

When the RPT button is pressed and held for more than 2 seconds, the disc repeat mode is activated; **DRT** will appear on the display and the play of the current disc will be continuously repeated. This mode is canceled in the same manner as before.

④② SHUFFLE PLAY SELECTOR (SHF)

When the SHF button is momentarily pressed, the **SHF** indication will replace the **CDC** indication on the display panel and the tracks on the disc will be played in a random, shuffled order. The Track Select buttons ③⑧ will also select tracks in the shuffled order instead of the normal progression. The Track Shuffle mode can be canceled by pressing the SHF button again or by activating the Track Select, Repeat Play or Scan functions.

When the SHF button is pressed and held for more than 2 seconds, the disc shuffle mode is activated; **DSF** will appear on the display and the play of the discs in the magazine will be played in a random shuffled order. This mode is canceled in the same manner as before.

CD CHANGER ERROR CODES

If a problem should develop while operating the CD changer, the error code “**Err**” may appear on the display panel. This can indicate a number of problems with the unit, including a mechanical error or an error in the microprocessor control of the changer. If the error code should appear, try ejecting and re-loading the magazine into the changer. While the magazine is out of the changer, make sure the discs are clean, undamaged, and loaded correctly (see Owner’s Manual of the CD changer). You may also try activating the RESET button ③② on the unit, but this will also erase the time and pre-set memories.

If the suggested measures do not solve the problem, contact an approved warranty station near you for further assistance.

WIRELESS REMOTE CONTROL OPERATION

The wireless remote control supplied with this model is capable of operating most of the features of the unit from a remote location. Each button on the remote control functions in the same way as the referenced button on the main unit. For optimal operation of the remote control, always aim it toward the Remote Sensor ③④ on the front panel of the main unit.

- ① **POWER** - See Main Unit ①
- ② **VOLUME (LEVEL) CONTROL**- See Main Unit ②, except press VOL **Y** to increase level, and press VOL **V** to decrease level
- ③ **SELECT BUTTON (SEL)** - See Main Unit ②, ③, ④, ⑤, ⑥, and ⑦
- ④ **PRE-SET SCAN-AUTO STORE TUNING (AS/PS)/MP3**- See Main Unit ⑮
- ⑤ **AM/FM BAND SELECTOR (BAND)/ENTER** – See Main Unit ⑧
- ⑥ **UP(9)/DOWN(8) TUNE/SEEK/TRACK** – See Main Unit ⑪

MANUAL SEEK TUNING – See Main Unit ⑫, except press **▶▶** to seek upward and press **◀◀** to seek downward.

CD TRACK SELECT – See Main Unit ⑳ and ⑳ except press **▶▶** to select a higher track number, press **◀◀** to select a lower track number.

CD CUE/REVIEW – See Main Unit ㉒ and ㉓ except press **▶▶** for Cue function, and press **◀◀** for Review function.

- ⑦ **RADIO PRE-SET MEMORY 1-6** - See Main Unit ⑮
- ⑧ **DISC UP SELECT (DISC +)** - See Main Unit ⑳
- ⑨ **DISC DOWN SELECT (-DISC)** - See Main Unit ㉑
- ⑩ **TRACK/DISC REPEAT (RPT)** - See Main Unit ㉒ and ㉓
- ⑪ **TRACK/DISC SHUFFLE (SHF)** - See Main Unit ㉔ and ㉕
- ⑫ **TRACK/DISC PAUSE (PAU)** - See Main Unit ㉖ and ㉗
- ⑬ **TRACK/DISC SCAN (SCN)** - See Main Unit ㉘ and ㉙
- ⑭ **MODE SELECTOR (MODE/7)** - See Main Unit ㉚
- ⑮ **TIME/FREQUENCY SELECT BUTTON (T/F)/0** - See Main Unit ㉛
- ⑯ **INFRARED SENDER** - Emits infrared signal to radio which is detected by the IR sensor ③④
- ⑰ **BATTERY COMPARTMENT** - Holds one 3-Volt Button Cell for remote wireless control operation.

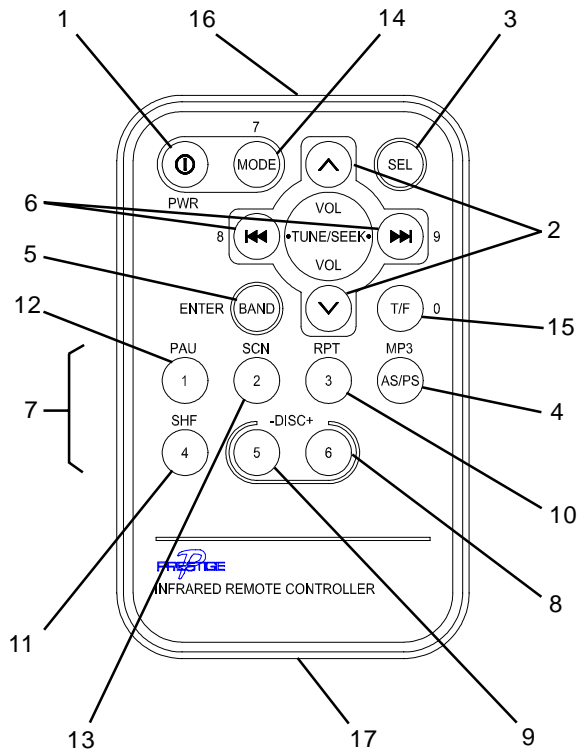

PLAYING MP3 MUSIC FILES

MP3 (Moving Picture Experts Group, Layer 3) are digital audio files that are compressed to about 1/10th the size of a CD recording. As a result, you can compress a CD song that has 50 megabytes of data into an MP3 that has only 4 or 5 megabytes.

The P-963ESP can play MP3s directly from files contained on a CD-R/RW, by using the MP3 buttons on the radio (or Remote Control).

MP3 CONTROLS

The following buttons represent control inputs, characters and/or numbers dedicated to the access of files on your MP3 CD.

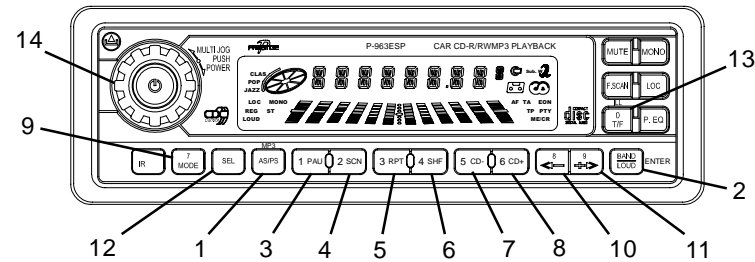



1. **AS/PS:** The AS/PS button, also labeled **MP3**, is used to search and/or access the Track Number and Directory/Album title; additional presses will momentarily access the disc serial number (if applicable), and display the current Directory/Album title. By using this button, you can quickly jump to a Directory/Album and then navigate within that area to locate and play a specific song/track.
2. **BAND/LOUD:** The BAND/LOUD button is also labeled **ENTER** for MP3 CD playback purposes; its function permits entry to the desired Directory/Album or Track after being accessed by the **MP3** (AS/PS) button.

3. **Preset 1:** During MP3 disc play, pressing this button in conjunction with the MP3 button, will select track number 1, or a track number containing this numeral. When a Directory or song title search is being made, this button also represents alphanumerical characters **A, B, C, 1**. Pressing the button consecutively scrolls through the characters.
4. **Preset 2:** This button functions in the same manner as Preset 1, except it represents alphanumeric characters **D, E, F, 2**.
5. **Preset 3:** This button functions in the same manner as Preset 1, except it represents alphanumeric characters **G, H, I, 3**.
6. **Preset 4:** This button functions in the same manner as Preset 1, except it represents alphanumeric characters **J, K, L, 4**.
7. **Preset 5:** This button functions in the same manner as Preset 1, except it represents alphanumeric characters **M, N, O, 5**.
8. **Preset 6:** This button functions in the same manner as Preset 1, except it represents alphanumeric characters **P, Q, R, 6**.
9. **MODE:** This button functions in the same manner as Preset 1, except it represents alphanumeric characters **S, T, U, 7**.
10. **MANU/SKIP (Down):** This button functions in the same manner as Preset 1, except it represents alphanumeric characters **V, W, X, 8**.
11. **MANU/SKIP (Up):** This button functions in the same manner as Preset 1, except it represents alphanumeric characters **Y, Z, Space, 9**.
12. **Select (SEL):** This button is used in conjunction with the MP3 button and MULTI JOG control knob to confirm selection of the alphanumeric character when choosing a specific Directory/Album and/or song title.
13. **Time/Frequency (T/F):** This button functions in the same manner as Preset 1, except it represents symbol/numeric characters **_, -, +, 0**.
14. **MULTI JOG CONTROL Up/Down:** The MULTI JOG control knob performs the same function as the other alphanumeric buttons when choosing a specific Directory/Album and/or song title; however, it allows quicker selection and entry of sequential Alphanumeric characters, and is used in conjunction with the SEL button which confirms each selected character before moving on to the next one.

NOTE: The -DISC (**Preset 5**) and DISC + (**Preset 6**) buttons also enable track selection in 10-track steps during normal CD play and when searching for files or directories.

LOADING AN MP3 DISC

As with a normal music CD, when an MP3 disc is initially loaded, **S--CDP** appears on the display for 5 seconds. The  indication illuminates and becomes animated, the  symbol lights; then **MP3 T** and the track number momentarily appear, followed by the ID Tag, if supported, and the scrolling song title on the display.

ACCESSING THE ID TAG

To access the ID tag, when supported, proceed as follows:

1. Press the MP3 (AS/PS) button until the ID Tag, if supported, is displayed.

NOTE: The ID TAG can specify the **Songname, Artist, Album, Year,** and/or **Comments.**

2. If no ID TAG is available, **--NO ID3** will appear on the display following **Comments.**

SELECTING THE TRACK NUMBER DIRECTLY

To select a desired track number directly, proceed as follows:



1. With the MP3 CD in the play mode, press the MP3 (AS/PS) button; **MP3 T** appears on the display followed by a blinking asterisk (*); then press the numeric key or combination thereof, to access the appropriate track number.
2. If the desired track number consists of two digits or less, the player will wait a few seconds for the ENTER (BAND/LOUD) button to be pressed; otherwise, the player will begin searching for the track automatically.
3. When the track is accessed, the track number appears on the display, followed by the song name if this information is available.

ALPHANUMERIC SEARCH FOR A DIRECTORY OR FILE

To search for a desired directory or file on the MP3 CD, proceed as follows:



1. With the MP3 CD in play mode, press the MP3 button until only a blinking asterisk (*), denoting character position, appears.
2. Then press the desired buttons, or use the AUDIO ADJUST control with the SEL button, to enter the characters of the directory or file name. Up to eight Alphanumeric characters can be entered for search.
3. Press the ENTER (BAND/LOUD) button to select the the directory/file name.
4. Press ENTER (BAND/LOUD) again to open the directory; (.) will be displayed, indicating that the directory is now open.
5. Then continue the search within the directory for the song title by using the buttons, but use the  button first.





NOTE: If the Directory/File is entered incorrectly, or does not exist, NOT FOUND will be displayed momentarily.

6. The contents (song titles, sub-directories) of the current directory can now be accessed and selected for play. Navigate the tracks using the  /  tuning buttons.
7. When the desired track title is accessed, press the ENTER button again to begin play of the selected song.

NAVIGATING FROM A CURRENT DIRECTORY

To search for a desired song from the current directory on the MP3 CD, proceed as follows:

1. With the MP3 CD in play mode, press the MP3 button until the blinking asterisk (*) appears.
2. Then press the desired buttons, or use the AUDIO ADJUST control with the SEL button, to enter the characters of the directory or file name. Up to eight Alphanumeric characters can be entered for search.
3. Otherwise, continue the search within the directory for the song title by using the  /  buttons, but use the  button first.
4. When the song title is accessed, press ENTER again to begin play of the selected song.

NOTE: The song Up/Down buttons ( / ) reflect those on the radio front panel; however, these buttons are slightly different on the Remote Control Unit and appear as: ( / ).

TROUBLESHOOTING

SYMPTOM	CAUSE	REMEDY
No Power	The car ignition is not on.	If the power supply is properly connected to the car accessory terminal, switch the ignition key to the ACC position.
	The fuse is blown	Replace the fuse.
Disc cannot be loaded or ejected.	CD already in player CD inserted upside down. CD extremely dirty or defective. Vehicle interior temperature too high. High condensation.	Remove the disc and insert new one. Insert the CD with label facing up. Clean the CD and/or replace it with a new one. Reduce the temperature using air conditioning controls. Leave the player off for an hour or so, then try again.
No Sound.	Volume is set at minimum. Wiring is not properly connected.	Adjust volume to desired level. Check wiring connections.
Sound Skips.	Installation angle exceeds 30 degrees. CD extremely dirty or defective. Skip protection circuit not operating correctly	Readjust the installation to less than 30 degrees. Clean the CD and/or replace it with a new one. Contact manufacturer for corrective action.
Operational controls/buttons not working.	Built-in microcomputer not operating properly. Front panel not properly engaged/installed. Contacts between panel and main unit are dirty.	Lower the front panel and press the RESET button. Make sure panel is properly affixed to front mounting plate. Clean contacts with a cotton swab soaked in isopropyl alcohol.
The radio does not receive properly.	The antenna cable is not connected or improperly connected.	Insert the antenna cable plug firmly into the radio antenna connector.
Station preset selection(s) not operating properly.	Received signals too weak.	Select stations manually.

12 MONTH LIMITED WARRANTY

AUDIOVOX CORPORATION (the Company) warrants to the original retail purchaser of this product that should this product or any part thereof, under normal use and conditions, be proven defective in material or workmanship within 12 months from the date of original purchase, such defect(s) will be repaired or replaced with new or reconditioned product (at the Company's option) without charge for parts and repair labor.

To obtain repair or replacement within the terms of this Warranty, the product is to be delivered with proof of warranty coverage (e.g. dated bill of sale), specification of defect(s), transportation prepaid, to the warranty center at the address shown below.

This Warranty does not extend to the elimination of car static or motor noise, to correction of antenna problems, to costs incurred for installation, removal, or reinstallation of the product, or damage to tapes, compact discs, speakers, accessories, or vehicle electrical systems.

This Warranty does not apply to any product or part thereof which, in the opinion of the Company, has suffered or been damaged through alteration, improper installation, mishandling, misuse, neglect, accident, or by removal or defacement of the factory serial number/bar code label(s). THE EXTENT OF THE COMPANY'S LIABILITY UNDER THIS WARRANTY IS LIMITED TO THE REPAIR OR REPLACEMENT PROVIDED ABOVE AND, IN NO EVENT, SHALL THE COMPANY'S LIABILITY EXCEED THE PURCHASE PRICE PAID BY PURCHASER FOR THE PRODUCT.

This Warranty is in lieu of all other express warranties or liabilities. ANY IMPLIED WARRANTIES, INCLUDING ANY IMPLIED WARRANTY OF MERCHANTABILITY, SHALL BE LIMITED TO THE DURATION OF THIS WRITTEN WARRANTY. ANY ACTION FOR BREACH OF ANY WARRANTY HEREUNDER INCLUDING ANY IMPLIED WARRANTY OF MERCHANTABILITY MUST BE BROUGHT WITHIN A PERIOD OF 30 MONTHS FROM DATE OF ORIGINAL PURCHASE. IN NO CASE SHALL THE COMPANY BE LIABLE FOR ANY CONSEQUENTIAL OR INCIDENTAL DAMAGES FOR BREACH OF THIS OR ANY OTHER WARRANTY, EXPRESS OR IMPLIED, WHATSOEVER. No person or representative is authorized to assume for the Company any liability other than expressed herein in connection with the sale of this product.

Some states do not allow limitations on how long an implied warranty lasts or the exclusion or limitation of incidental or consequential damage so the above limitations or exclusions may not apply to you. This Warranty gives you specific legal rights and you may also have other rights which vary from state to state.

U.S.A. : AUDIOVOX CORPORATION, 150 MARCUS BLVD., HAUPPAUGE, NEW YORK 11788 • 1-800-645-4994

CANADA: CALL 1-800-645-4994 FOR LOCATION OF WARRANTY STATION SERVING YOUR AREA

128-4270E



© 2004 Audiovox Electronics Corp., Hauppauge, NY 11788

Printed in China

128-6981

-20-

128-6981
20 of 20